

Type 33

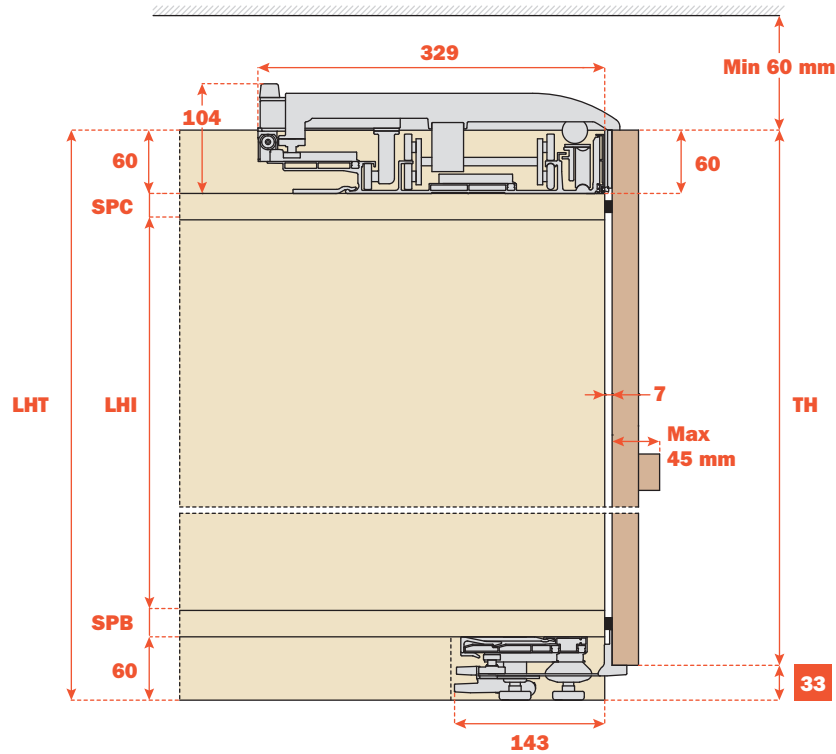

Standard

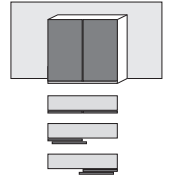
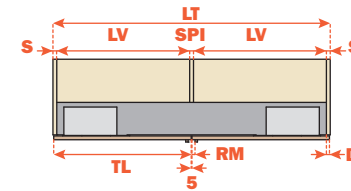

Reverso

- special order -

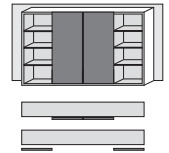
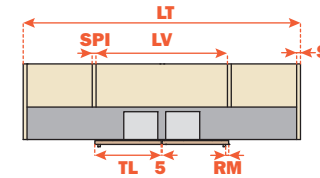

Step

- special order -

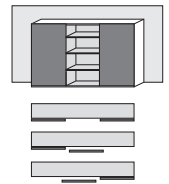
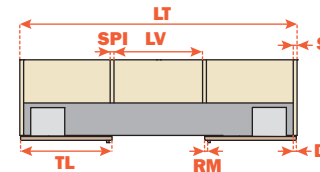

Maximum weight of a door 70 Kg	
LHT	Total cabinet height (mm)
SPC	Top panel thickness (mm)
LHI	Internal cabinet height (mm)
SPB	Bottom panel thickness (mm)
TM	Door thickness + handle (mm) • min 18 mm - max 45 mm
TH	Door height (mm) • max 3000 mm
T	Door thickness (mm) • min 18 mm - max 30 mm
LT	Total cabinet width (mm)
SPI	Central panel thickness (mm)
S	Side panel thickness (mm)
TL	Door width (mm) • min 800 mm - max 2000 mm
RM	Distance from edge of the door to the handle (mm)
D	Door overlay on side panel • max 100 mm
LV	Internal cabinet width (mm)

Contact name
Company
Date
Project
Distributor
Notes